

Replace the Motor Coil – Classic

Entire document: 4 pages

THIS DOCUMENT CONTAINS GENERAL INSTRUCTION FOR SERVICING STENNER PRODUCTS. PLEASE BE SURE TO READ ALL SAFETY INFORMATION.

! **NOTICE:** Indicates special instructions or general mandatory action.

! **NOTICE:** Read all safety hazards before installing or servicing the pump. The pump is designed for installation and service by properly trained personnel.

! **NOTICE:** Use all required personal protective equipment when working on or near a chemical metering pump.

! **NOTICE:** Install the pump so that it is in compliance with all national and local plumbing and electrical codes.

! **NOTICE:** Use the proper product to treat potable water systems, use only chemicals listed or approved for use.

! **NOTICE:** Install the pump to work in conjunction with pool, spa, well pump, or system controls.





Safety Information – Classic

 **WARNING** Warns about hazards that **CAN** cause death, serious personal injury, or property damage if ignored.

 **ELECTRIC SHOCK HAZARD**

 **WARNING** **ELECTRIC SHOCK HAZARD:**
Pump supplied with grounding power cord and attached plug. To reduce risk of electrical shock, connect only to a properly grounded, grounding type receptacle. Install only on a circuit protected by a ground-fault circuit interrupter (GFCI).

 **WARNING** **HAZARDOUS VOLTAGE:**
DISCONNECT power cord before removing motor cover for service. **Electrical service by trained personnel only.**

 **AVERTISSEMENT** **RISQUE DE CHOC ELECTRIQUE:**
Cette pompe est équipée d'une fiche de mise à terre. Pour réduire le risque de choc électrique, s'assurer que la fiche est bien raccordée à une prise de courant avec une connexion de mise à terre. Installer seulement sur un circuit protéger par un interrupteur protéger par une mise à la terre.

 **WARNING** **EXPLOSION HAZARD:**
This pump is not explosion proof. **DO NOT** install or operate in an explosive environment.

 **DO NOT** alter the power cord or plug end.

 **WARNING** **RISK OF CHEMICAL EXPOSURE:**
Potential for chemical burns, fire, explosion, personal injury, or property damage. To reduce risk of exposure, the use of proper personal protective equipment is mandatory.

 **DO NOT** use receptacle adapters.

 **WARNING** **RISK OF FIRE HAZARD:**
DO NOT install or operate on any flammable surface.

 **DO NOT** use pump with a damaged or altered power cord or plug. Contact the factory or an authorized service facility for repair.

 **WARNING** **RISK OF CHEMICAL OVERDOSE:**
To reduce risk, follow proper installation methods and recommendations. Check your local codes for additional guidelines.

 **CAUTION** Warns about hazards that **WILL** or **CAN** cause minor personal injury or property damage if ignored.

 **This is the safety alert symbol. When displayed in this manual or on the equipment, look for one of the following signal words alerting you to the potential or personal injury or property damage.**

 **CAUTION** **PLUMBING:**

Chemical feed pump installation must always adhere to your local plumbing codes and requirements. Be sure installation does not constitute a cross connection. Check local plumbing codes for guidelines.

 **PUMP SUITABLE FOR USE OUTDOORS** when installed with a Stenner Rain Roof Part No. MP90000.

 **NOTICE: Indicates special instructions or general mandatory action.**

 Electrical installation should adhere to all national and local codes. Consult a licensed professional for assistance with proper electrical installation.

 **NOTICE:** This metering pump is portable and designed to be removable from the plumbing system without damage to the connections.

 Removing power from pool/spa recirculation pump must also remove power from pump.

 **NOTICE:** This metering pump and its components have been tested for use with the following chemicals: Sodium Hypochlorite (10-15%), Muriatic Acid (20-22% Baume, 31.5% Hcl), and Soda Ash.

 The use of an auxiliary safety device (not supplied), such as a flow switch or sensor, is recommended to prevent feed pump operation in the event of a recirculation pump failure or if flow is not sensed.

 **NOTE:** Cette a pompe de dosage et ses composants ont été testés pour utilisation avec les produits chimiques suivants; Hypochlorite de Sodium (solution de 10-15%); Acide Muriatique (20-22% Baume, 31.5% Hcl); Cendre de Soude.

 Point of chemical injection should be beyond all pumps, filters, and heaters.

 Suitable for indoor and outdoor use.

 Convient pour usage intérieur et extérieur.



Replace the Motor Coil – Classic

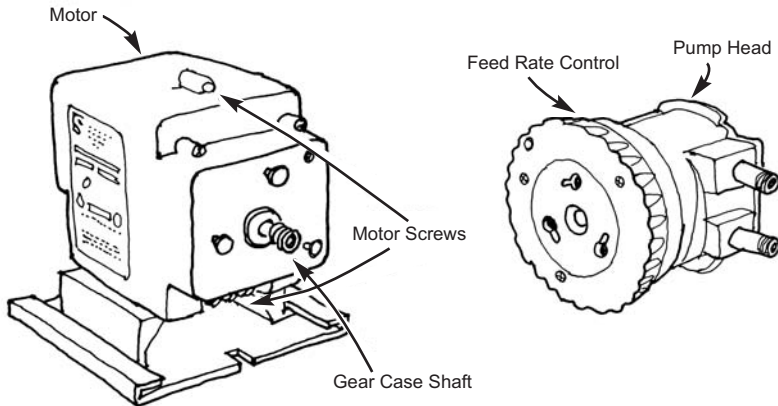

1. Disconnect power to pump.
2. Remove motor base. Remove two motor cover screws.
3. Invert the pump and use the pump head as a stand to work on the motor. See illustration.
4. Remove fan and set aside.
5. Disconnect ground wire (with eyelet) and set screw aside.
6. Cut the power cord and coil lead wires from motor cover at the wire nut (four cuts total). Set cover to the side.
7. Remove and set aside
 - Two coil screws and washers from the rotor bracket
 - Plastic bearing bracket (amber)
8. Remove coil and discard.

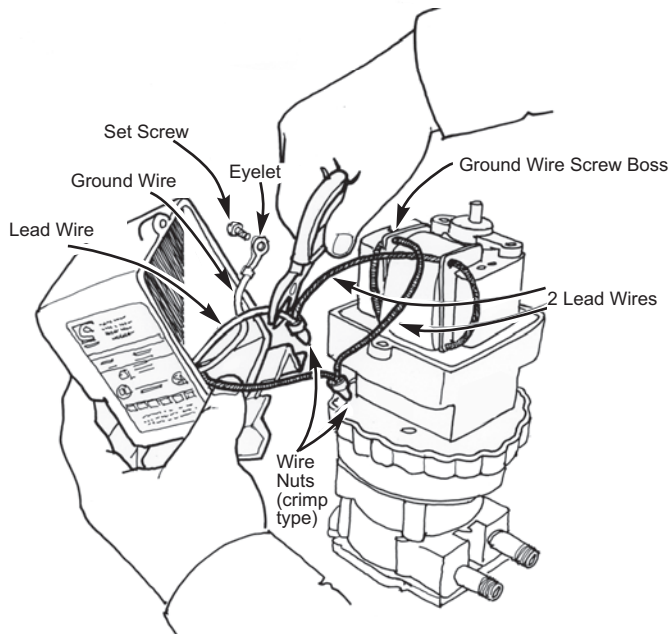
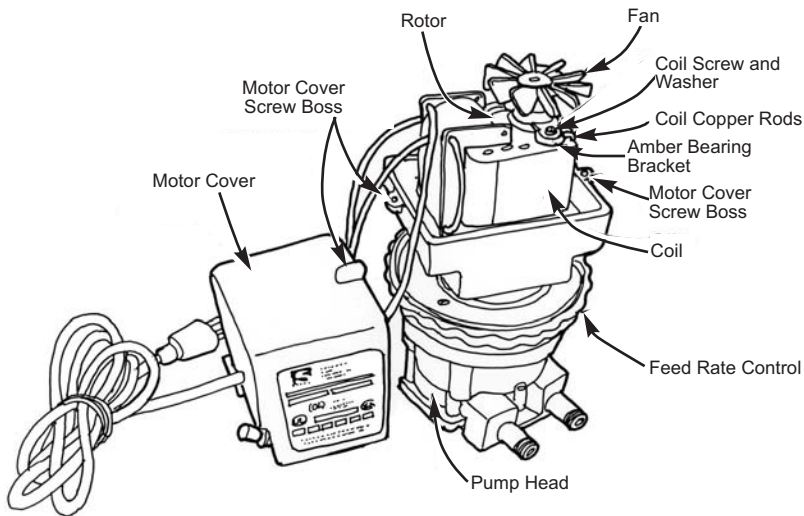

Replace the Motor Coil – Classic

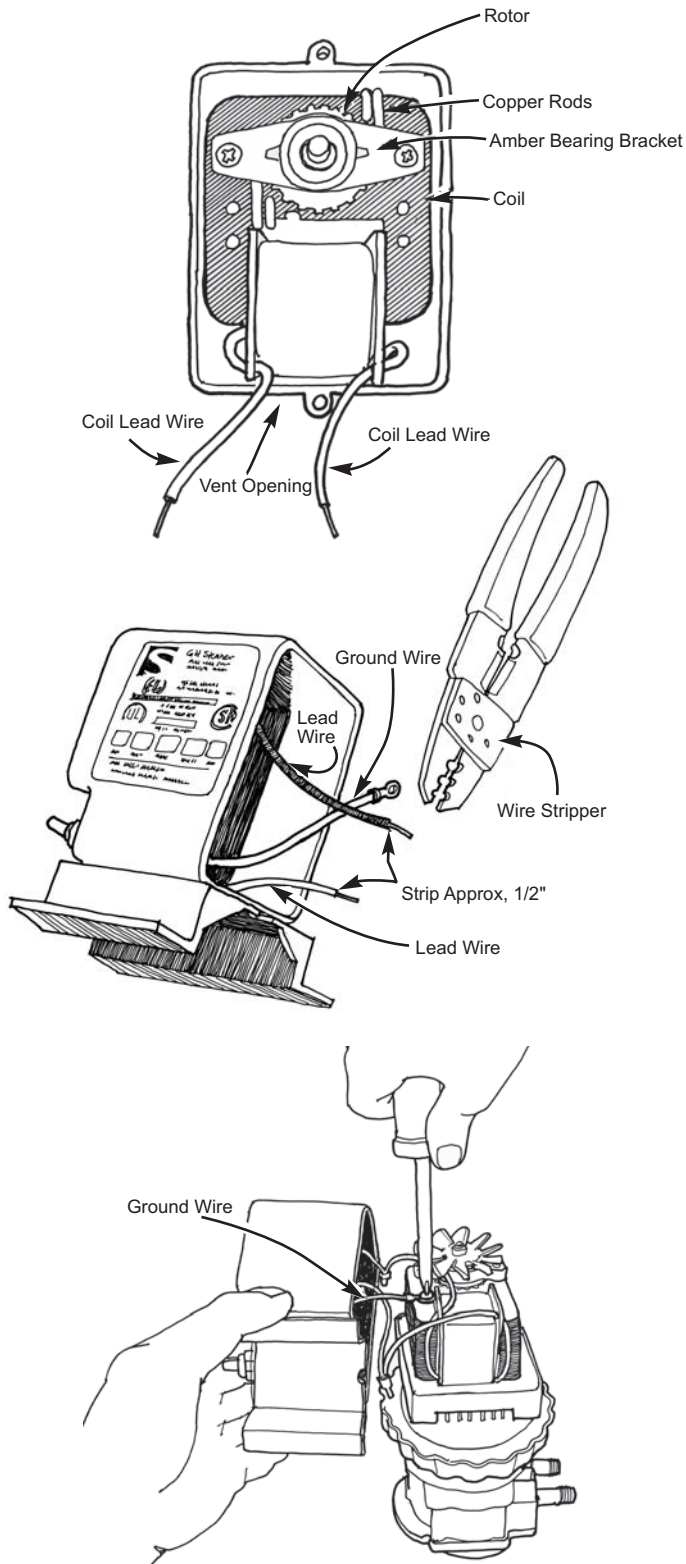

9. Install new coil over rotor on the remaining amber bracket. The correct orientation is with two copper rods in the upper right corner and the vent opening at the bottom of the gear case. Place bracket back on the rotor and securely seat into new coil. Install screws and washers and fasten bracket to coil.
10. With the metal band facing the bracket, press fan flush on rotor shaft.
11. With wire strippers set at 16 gauge, strip approximately 1/2" from the power cord and on/off switch lead wires in the motor housing.
12. Secure ground wire (with eyelet) to motor coil.
13. Crimp the stripped lead wires to each of the new coil lead wires.
14. Tuck wire nuts into bottom of motor cover and secure cover back in place. (Before tightening, reverse cover screws to catch original threads.)
15. Apply power to motor and test.